

HiFocus 161i

CNC-Control

X102 (CNC)

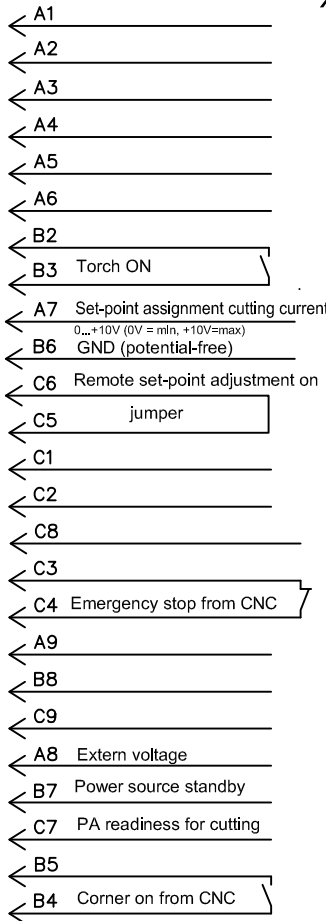
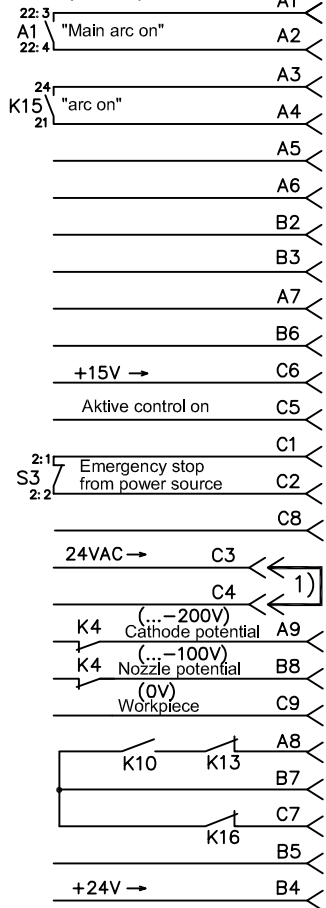

X102

look at contacts

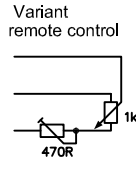
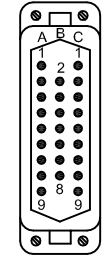

1) Remove jumper in case of CNC operation

X104 (CNC)

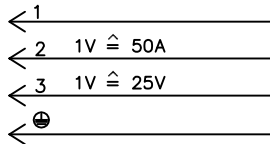
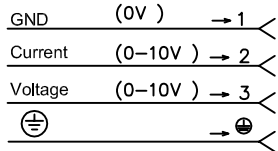

X104

look at contacts



X106 (CNC)

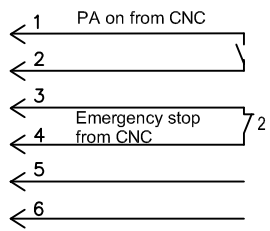
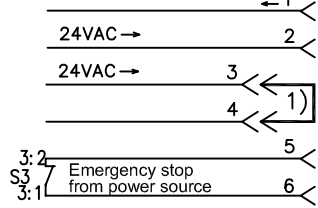

X106

look at contacts

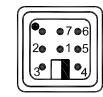

X4.1 (CNC-RS 485)

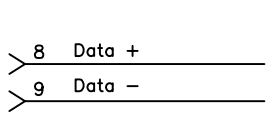
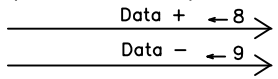

X4.1

look at contacts

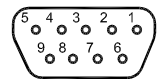

valid from: serie 11001

				Datum	Name	Benennung
		bearb.	24.03.11	Jagieniak		Wiring diagram HiFocus 161i CNC-Interface X102/X104/X106/X4.1
		gepr.				
		Norm				
						Zeichn.-Nr.
						.11.034.902.SP2 a
						Blatt
						Bl.
Zust	Aenderung	Datum	Name	Urspr.		

